

Gröup®



RAINFOREST FALLS

Rainforest Falls
Main Set Decorating

Main Set Decorations

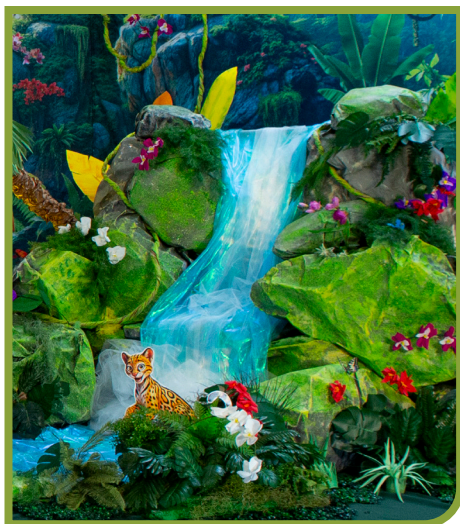

Waterfall

What you'll need:

- boxes (We used 4 large, 5 medium, and 1 small for our base.)
- packing tape
- Cool Connectors*
- gray paper
- PVC or cardboard tube about 48" long
- 12 yards shimmery light-blue organza fabric
- 6 yards white tulle
- 3 panels of Water Fabric*
- Rainforest Rocks painted in blue and green (For our set we used 8 large, approximately 2' x 3' x 18', green-painted rocks, 4 medium-size, approximately 18" x 16" x 16", and a handful of small 6" x 6" x 8". See separate instructions.)
- greenery
- Tissue Paper Vines*
- Paper Grass Sprouts

What you'll do:

Before you begin, build Rainforest Rocks (see separate instructions).

Step 1: Stack boxes in two columns about 5' tall with a 2' gap between the columns. Use tape or Cool Connectors to attach boxes together.

Step 2: Crumple long lengths of gray paper. Drape and tape the gray paper in place over the stacked boxes so it lays flat against the boxes. This will allow the layers of Rainforest Rocks to rest against and on top of the covered tower of boxes.

Step 3: At the top of the two columns, place a PVC pipe or cardboard tube so it spans across the 2' gap. This helps hold up the fabric. (See diagram.)

Step 4: At the base about 18" off the ground, place a large, flat, green-painted rock that spans across the gap of the two columns. (Our rock was 32" x 32" x 5".)

Step 5: Place large, green Rainforest Rocks in front of the crumpled paper layer. It's OK if some of the crumpled paper shows. After getting all the Rainforest Rocks in place, use the same dry brush painting technique as the base layer of Rainforest Rocks to add white and black details to any crumpled paper that's showing. This helps to visibly blend the crumpled paper and the Rainforest Rocks together.

Step 6: Place blue shimmery fabric at the top of the two columns, making sure it fills in the gap. Tape or pin fabric in place on the back, top edge of each column. Then drape the fabric over the bar, allowing it to drape down and onto the flat rock near the base of the columns.

Step 7: Beginning at the top of the waterfall, place white tulle over the blue shimmery fabric. At the base of the waterfall, create a mist effect by bunching up the tulle in a billowy cloud.

Step 8: Place Water Fabric at the base of the waterfall to create a pool that is wide at the waterfall's base and gets thinner as it travels back to meet the fabric backdrop.

Step 9: Lay blue shimmery fabric over the Water Fabric.

Step 10: Add blue Rainforest Rocks at the base of the waterfall and near the pool's edge.

Step 11: Greenery, vines, and flowers can be added to the waterfall. Rocks, Foliage Clusters, and Paper Grass Sprouts add the finishing touches to the water's edge.

*available at group.com.

Rainforest Rocks

What you'll need:

- cardboard boxes in a variety of sizes from 9"x12" to 2'x3'
- hammer
- gray bulletin board paper (gray base color paper)
- packing paper
- scissors
- clear packing tape
- paint, 1 quart each (flat finish)
 - black
 - white
 - Hills of Ireland—dark green
 - Crisp Green—light lime green
 - Lemon Tart—bright yellow
 - Flashy Sapphire—dark blue
 - Riviera Blue—light blue
- paintbrushes and sponges
- disposable gloves
- disposable plates
- disposable paint drop cloth

What you'll do:

Box Rocks (We used these for larger waterfall boulder-size rocks.)

Step 1: Smash the box so it no longer has square corners.

Step 2: For a rocky texture, tape some paper wads to the outside of the box.

Step 3: Cover the entire rock with one large piece of paper, then secure and tape the ends down on the underside of the box. Finish with paint.

Paper Rocks (We used these for the path and smaller rocks.)

Step 1: For smaller rocks, simply use paper wads instead of boxes.

Step 2: Place the paper wad in the center of a piece of gray paper.

Step 3: Wrap with paper, then secure the ends of the paper with tape. Finish with paint.

Paint Your Rocks

Tip: At our field test we underestimated the “splatter range.” Choose your painting location wisely. Outside may be best.

Base Paint for all Rocks: Using a dry brush technique, paint the creases and the shadowy spots black. Let the creases and the wrinkles of the paper grab the paint. Next add white highlights on the surface of the rock. For a plain gray rock, leave painted in just this base layer. We used gray rocks along the Canvas Stone Path.

Green Mossy Rock: Dry brush some yellow on the top of the rock. For a mossy effect, splatter green and then light green over the top of the rock.

Blue Water Rock: For blue tone (water reflecting off the rock) dry brush or sponge on blue and white to create different shades of blue water on the rock.





Foliage Clusters

What you'll need:

- 2" x 4' x 8" Styrofoam (for the main set we used 3 sheets)
- green paint
- paint opener
- plastic drop cloth
- paintbrush
- 1 can of Great Stuff
- gloves
- hot knife
- marker
- greenery, Fabric Leaves on Wires, Orchids, Folded Paper Leaves
- Tissue Paper Grass Mat*

What you'll do:

Step 1: Draw the base shape on the piece of foam. Our bottom piece was 48" wide. Then make two smaller pieces that are slightly smaller than the base piece. The last piece can be much smaller.

Step 2: Use a hot knife to cut out the foam shapes. Bevel the edges. Tip: Cut the foam outside or in a well-ventilated area.

Step 3: Put the plastic drop cloth on your table. Stack the foam to create a sturdy tiered base.

Step 4: Glue the pieces together using Great Stuff. Put a bit of Great Stuff between two pieces of foam, and then press the foam pieces together. Peel the two pieces apart and press together again; do this several times so that the air is pressed out of the Great Stuff. This process helps glue the pieces together without the Great Stuff expanding. Allow to dry.

Step 5: Paint the entire base green. Allow to dry.

Step 6: Fluff the Tissue Paper Grass Mat and place it on top of the foam.

Step 7: Poke greenery, fabric leaves on wires, orchids, and Folded Paper Leaves into the foam base.

Tip: The back is wide to create a counterbalance so the clump doesn't tip over.



*available at group.com.

Fallen Log

What you'll need:

- 8" x 4" concrete form tube or 3 4" x 4" carpet tubes
- 1 roll of newsprint
- 1 can of brown spray paint
- clear packing tape
- disposable gloves
- 2 cans of Great Stuff expanding foam insulation
- paint (orange, cream)
- paintbrushes
- disposable paint tarp
- disposable plate
- long serrated kitchen knife
- mask (optional)

What you'll do:

Step 1: If you're using carpet tubes, tape the 3 tubes together to form a wide tube. Crumple newsprint before wrapping the concrete form tube. Then wrap the tube with several layers of crumpled paper, twisting the paper as you go for a wood effect. Tip: On the last layer, to avoid painting on shiny tape, we rolled pieces of tape and tucked under the paper to secure the edges.

Step 2: Give the log texture by adding lines of spray insulation. Cover one half of the log with lines. Allow to dry.

Step 3: Add lines to the other half of the log.

Step 4: At one end of the log, stack two more layers of lines, making it wide like a tree trunk at one end and taper smaller at the other. (When placed on stage, this helps with forced perspective.)

Step 5: Add insulation to fill in both ends of the log. Allow to dry.

Step 6: At the wide end, use a serrated knife to cut the end flat.

Step 7: Paint the entire log with brown spray paint. Let it dry.

Step 8: Paint orange on the surface of the log using a dry brush technique, allowing the texture of the log to pick up the orange paint to create barklike texture. Use the same technique on the ends of the log.

Step 9: Add cream highlights.

Step 10: Use cream paint to make concentric circles on the end of the log.





Leaning Palm Tree

What you'll need:

- 1"x2"x8' piece of wood cut into 36" and 46" pieces
- dark brown paint
- tape measure
- paintbrush
- wire cutter
- scissors
- saw
- 6-7 Paper Folded Leaves on Sturdy Stems (see separate instructions)
- safety goggles
- 12 zip ties, 12
- drill
- Palm Tree Base (see separate instructions)
- 6 screws, 1¾"
- 30 brown lunch sacks

What you'll do:

Step 1: Cut the 1x2 into two pieces, 36" and 46" lengths.

Step 2: Screw the pieces of 1x2 together so that there is a bend to the trunk.

Step 3: Cut slits in the bottom of each lunch sack.

Step 4: Attach the 1x2 trunk to the Palm Tree Base.

Step 5: Thread the lunch sacks onto the trunk so that they scrunch up one on top of the other. Tip: Load them on from the cut side of the lunch bag.

Step 6: Zip tie Paper Folded Leaves to the top of the tree. If necessary, move the paper sacks to help cover where the leaves are attached to the tree. Clip the zip tie ends.

Step 7: Add paint to the trunk by dry brushing.

Palm Tree Base

What you'll need:

- 6-foot 2x4 cut to the following lengths: 3 pieces 16", 2 pieces 12"
- pencil
- 12-15 wood screws, 3"
- circular saw
- measuring tape
- drill, drill bit, driver bit

What you'll do:

A stable stand is created by adding a length of 2x4 horizontally on each side of the vertical 2x4 post, creating four feet at 90-degree angles. The longer the length of the feet, the more stable the stand, but the larger the footprint. These measurements work well for securing a 10-foot or shorter carpet tube.

Step 1: Measure and mark the 2x4 with three 16-inch lengths and two 12-inch lengths.

Step 2: Cut the 2x4 in the lengths you marked.

Step 3: Stand a 16-inch piece vertically, and create a 90-degree "L" shape by placing a 16-inch length at the base of the vertical piece, laying it on its 2-inch side and overlapping on the 4-inch side of the vertical (4-inch sides are together and overlapped 4 inches) flush at the corner. Drill 2 pilot holes and screw together.

Step 4: Turn the "L" 90 degrees and lay a 12-inch piece on its 2-inch side. This piece will cover the 2-inch side of the vertical piece and butt up against the 16-inch horizontal piece previously placed. Drill 2 or 3 pilot holes and screw in place, attaching screws into both the vertical and horizontal sections.

Palm Tree Base continued:

Step 5: Turn the structure 90 degrees and lay the remaining 16-inch piece on its 2-inch side, this piece will cover the 3-inch side of the vertical piece and butt up against the 12-inch horizontal piece previously placed. Drill 2 or 3 pilot holes and screw in place, attaching screws into both the vertical and horizontal sections.

Step 6: Turn the structure 90 degrees and lay a 12-inch piece on its 2-inch side. This piece will cover the 2-inch side of the vertical piece and butt up against the 16-inch horizontal piece previously placed. Drill 2 or 3 pilot holes and screw in place, attaching screws into both the vertical and horizontal sections.

Leaning Palm Tree on Palm Tree Base

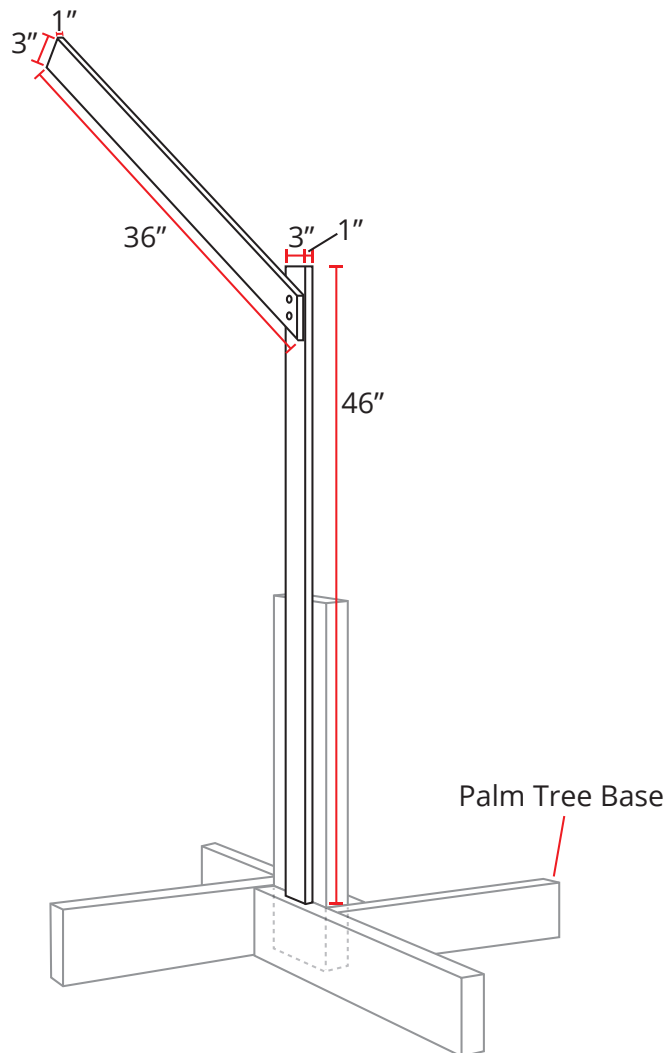

Tip: We found that we needed to use a sandbag to weigh the tree down on stage.



Twisted Paper Vines

What you'll need:

- a friend (This project is much more fun with a friend!)
- roll of 12" wide masking paper (available in the paint department of hardware stores)
- drill
- packing tape
- green or brown paint
- paintbrush
- paper plate
- gloves
- drop cloth

What you'll do:

Step 1: Tape the end of the paper to the drill so it's only taped to the spinning portion of the drill. Safety first: Make sure the drill is off.

Step 2: Have a friend hold the roll of paper so it easily spins paper off the roll. (Putting index fingers in the ends of the roll works great.)

Step 3: Roll off about 3-4' of paper before turning on the drill. As the drill starts spinning, widen the distance between the drill and the paper roll by each person taking a step back.

Step 4: Prep for painting by putting down a drop cloth. Paint one side of the vine using the dry brush technique. Let the vine dry. Then paint the other side of the vine.



Sturdy Stem (used to build Orchid, Paper Folded Leaves,

Birds of Paradise)

What you'll need:

- scissors
- green crepe paper
- floral tape
- 16-gauge galvanized wire (sold in a roll; we purchased a 200 roll)
- wire cutter
- tape measure

What you'll do:

Step 1: Cut a 60" length of 16-gauge galvanized wire.

Step 2: Fold the wire in half and twist together.

Step 3: Wrap the twisted wire with crepe paper and floral tape so that the crepe paper makes the wire thicker and all you see is the floral tape, no wire or crepe paper. When you get done wrapping, if you have any crepe paper showing, just cover with pieces of floral tape.

Tip: The far ends of the wires need space to rotate. As you work your way down twisting the wire, the ends become easier to manage.

Orchids

What you'll need:

- 2 colors of crepe paper in large sheets (for body of flower)
- 1 sheet of dark green crepe paper for leaves (for body of flower)
- crepe paper rolls (green roll and yellow)
- Orchid Petals template
- pencil
- scissors
- hot glue
- markers (coordinate colors with your choice of crepe paper)



What you'll do:

Step 1: Cut out the Orchid Petals template.

Step 2: Trace the petal template onto the crepe paper. Cut the large and medium petals out of one color and the smallest petal out of a contrasting color. Cut the green leaf pieces. Cut six yellow center pieces. Fold hot dog style, and fringe on the fold. For each bloom you need one petal of each size and one center.

Step 3: Draw dots and lines to add detail on the small flower petals.

Step 4: Pull at the petals a bit to get them to curl up.

Step 5: Glue petal pieces together at the center.

Step 6: Glue the center pieces to the flowers.

Step 7: Glue the blossoms to the Sturdy Stems. Then add a 1" circle of the same color as the petals to the back to help hold it. Allow glue to dry.

Step 8: Glue two green leaves below the petals, pinching the crepe paper to the stem. Pull at the green leaves a bit to get them to curl up.

Note: Each orchid stem uses four to six blooms and two green leaves.



Birds of Paradise

What you'll need:

- green and purple crepe paper
- light and dark orange construction paper
- Sturdy Stem
- Birds of Paradise template
- stapler
- hot glue gun
- scissors
- pen

What you'll do:

Step 1: Trace orange flower petals. It takes five to six per flower. We used two different shades of orange and mixed and matched the colors as we built the flower. Tip: This is a good take-home project.

Step 2: Trace the large and small leaf patterns on green crepe paper.

Step 3: Trace the stamen on purple crepe paper, at the fold.

Step 4: Cut out everything you trace.

Step 5: Fold the orange pieces in half, hotdog style.

Step 6: Nest three or four orange petals so that they nest together in a fan shape, then fold a large petal so you can tuck the fanned pieces into the bottom portion of the folded petal. Staple where the pieces meet to hold it together.

Step 7: Tuck the purple stamen by wedging it into the orange leaves.

Step 8: Fold one green leaf hamburger style. Add it to the flower by stapling. To help hide the staples, hot glue the last green leaf in place.

Step 9: Hot glue a Sturdy Stem to the back of the flower. Cut a circle of green crepe paper and hot glue it to cover where the Sturdy Stem is attached.



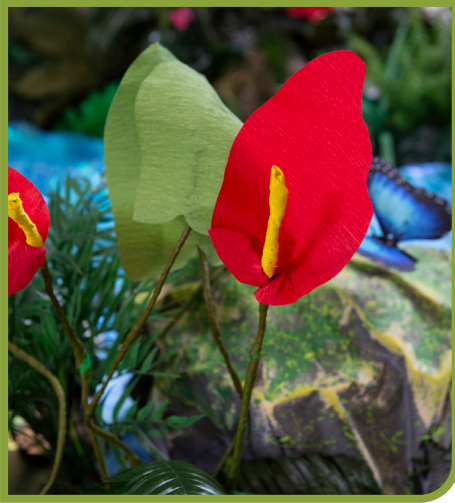

Anthuriums

What you'll need:

- red and green crepe paper (1 sheet of each per flower)
- 1 roll of yellow crepe paper (about 8 inches per bloom)
- scissors
- hot glue gun
- pen
- Sturdy Stem
- Anthurium template
- floral tape

What you'll do:

Step 1: Trace lots of green leaves and red petals.

Step 2: Cut out the petals and leaves.

Step 3: For the red flower, add hot glue to the end of the Sturdy Stem. Wind the yellow crepe paper down about 3 inches and use floral tape to secure the end to the Sturdy Stem.

Step 4: Add a dollop of hot glue on the wide end of the red petal. Glue the petal onto the stem where the yellow crepe paper ends (about 3 inches down).

Step 5: For the green leaf, add a dollop of hot glue on the center of the leaf. Note: The stem is on the top of the leaf. Pinch the leaf to adhere to the stem. Gluing the stem to the top of the leaf allows the leaf to form a cuplike shape just like a real Anthurium.



Cupcake Liner Flowers

What you'll need:

- cupcake liners (5 per flower)
- scissors
- hot glue
- 20-gauge floral wire, 18" long

What you'll do:

Step 1: Count out five cupcake liners. Leave the liners stacked together. Cut 1" V shapes out along the wavy edge of the liner; this will leave ½" petal shapes all the way around the liner. (Save some of the scrap cuttings to use when you glue the flower to the wire.)

Step 2: Separate the cut liners so they are no longer stacked. Each cut piece is one flower layer.

Step 3: Pinch a cut liner together and glue it to the center of a flat flower layer.

Step 4: Pinch the flat layer at the center and glue it to the center of a flat flower layer. Continue the process until all five flower layers are pinched together and glued, creating a round flower bloom.

Step 5: Add glue to the center back of the flower, press the floral wire into the glue, and then add a scrap of liner to the glue (more glue may need to be added). The scrap helps hold the wire to the back of the flower.

Paper Grass Sprouts

What you'll need:

- green construction paper
- wire cutter
- scissors
- glue stick
- 20-gauge floral wire (18" long)

What you'll do:

Step 1: Cut blades of grass by cutting deep, narrow V's, leaving a 1" uncut margin at the edge of the paper. Do this the entire length of the paper. (We cut several pieces of paper at a time.)

Step 2: Lay a cut blade piece down flat. Cover the 1" margin with glue.

Step 3: Lay a floral wire in the glue; trim the wire if necessary. Press another blade piece on top, sandwiching the wire between the two blade pieces. Line up the bottom edges to ensure the grass will stand up on its own.



Fabric Leaves on Wire

What you'll need:

- fabric leaves
- poster board or thin cardboard (like cereal boxes)
- 18-gauge green floral wire
- scissors
- hot glue
- pencil

What you'll do:

Step 1: For a small leaf, cut a piece of thin cardboard 1/2" wide and about 2" shorter than the length of the leaf. For large leaves, trace the leaf on a piece of thin cardboard to create a pattern. Then cut out the cardboard about 1/2" smaller than the traced image. For each large leaf, you will need a cardboard piece cut 1/2" smaller than the leaf.

Step 2: Place hot glue on the cardboard, then put a floral wire in the center of the cardboard. Press the fabric leaf into the glue, sandwiching the floral wire between the cardboard and the fabric leaf.



Paper Folded Leaves

What you'll need:

- large sheets of green art paper (available in the framing department at Hobby Lobby)
- hot glue
- scissors
- paint (green, yellow, white)
- green 18-gauge wire (18") or a Sturdy Stem
- disposable plate
- paintbrush or foam brush
- gloves

What you'll do:

Step 1: Fold the paper in half hot dog style.

Step 2: Cut a large half-almond shape out of the paper.

Step 3: Beginning at the narrow tip, fold over about 1", then flip the paper over and fold it the opposite way. Continue to fold accordion-style down the entire length of the paper. Fold so the veins of the leaf go up to the point.

Optional: If you want to add different texture to your leaf, cut a fringe on the edges of the leaf.

Step 4: Open the leaf and glue the wire to the center of the leaf.

Step 5: To give the leaf even more detail, dry brush the folds with a contrasting color.





Foam Leaves

What you'll need:

- roll of EVA high-density foam in white (we used a 24"x60"x4mm)
- scissors
- wooden marshmallow roasting stick (stands straight up) or 3/16"x48" wood dowel (for a bendy-looking leaf)
- hot glue
- paintbrushes
- paper plates
- paint tarp
- disposable gloves
- leaf templates (see end of instructions)
- pen
- paint [we used Behr Flat Matte Crisp Green, Bling Bling (yellow) Rhumba Orange, Hills of Ireland (darker green), Fire Cracker (red), Royal Liqueur (brown)]

What you'll do:

Step 1: Trace large leaf shapes on the foam.

Step 2: Cut out the large leaf shapes. You may want to create a few.

Step 3: Glue the dowel or stick on the back of the leaf. Allow the glue to dry. To get a slightly different leaf texture, add glue to the base of the leaf and pinch closed over the dowel.

Step 4: Paint the back of the leaf with the base color of your choice. Let dry. Then flip over and paint the front of the leaf the base color.

Step 5: In a contrasting color, dry brush leaf details on to the top of the leaf. Paint a large, thin line down the center and then whips of brush strokes from the center to the edge.

Tip: Unroll the foam the day before and lay flat on the floor with the curled edges down. Place books or something heavy on top of the corners and edges to flatten the roll. This will make it easier to trace and cut the leaves.



Red Foam Plant

What you'll need:

- foam base
- paint (green, dark green, yellow)
- paintbrushes
- 6 red-painted foam leaves (see Foam Leaves for instructions)
- green fabric leaves
- store-bought green foliage

What you'll do:

Step 1: Use the darker green paint to make almond-shaped marks on the leaf. Add yellow wisps over the green. Tap or shake your paintbrush to add a few speckles. Let dry.

Step 2: Paint the foam base green. Let dry.

Step 3: Insert the red leaves into the green foam base.

Step 4: Add the green fabric leaves and the store-bought green foliage to make a plant.

Canvas Stone Path

What you'll need:

- canvas tarps (we used two 4'x12' for the main stage)
- paint (brown, black, white, and tan)
- paint sticks
- paint opener
- plastic drop cloth
- 2 regular-size sponges
- 2 large sponges
- scissors
- disposable gloves
- disposable dinner plates

What you'll do:

Step 1: Lay out the plastic drop cloth.

Step 2: Lay the canvas tarp on top of the drop cloth.

Step 3: Cut the sponges into stone shapes. We used four different sizes to create our canvas path. One large, one medium, small oval, and small round.

Step 4: Dampen the sponges.

Step 5: Pour a small puddle of each color paint onto the plate.

Step 6: Dip a damp sponge into the puddles of paint, grabbing at least a couple different colors. Press the sponge onto the canvas in two or three places, leaving lots of space in between. As you dip and stamp, the paint puddles will mix and marble—that's what helps the stamping look like stone. Continue dipping and stamping with different size sponges, filling the spaces in with different sizes and color patterns. Pour more paint puddles as needed. We rinsed and wrung out all our sponges after every 50 stamps and got a fresh plate.



Spray Mount Rainforest Posters

What you'll need:

- posters from the Giant Decorating Poster Pack
- scissors
- binder clips
- spray adhesive
- gloves
- disposable paint tarp
- foam board
- hot glue gun and glue sticks
- craft knife or utility knife
- cutting mat

What you'll do:

Step 1: Roll the poster so the back of the poster is on the outside of the roll and the images are on the inside of the roll. Use binder clips to attach the edge of the poster to the edge of a sheet of foam board the same size as the poster.

Step 2: Spray the foam board with spray adhesive. (Make sure you are in a well-ventilated area.) Unroll the poster a few inches at a time, pressing firmly to the foam board as you unroll a little more. Continue spraying, unrolling, and pressing the entire length of the poster.

Step 3: Use a craft knife or utility knife to cut the poster and foam board out together, leaving crisp, clean edges with no margins.

Step 4: To seam pieces of the poster together to make a large piece, such as the (horse HLA, robot Weekend, Rainforest Theme Sign), place the pieces facedown, with the foam board facing up. Push the two pieces together, making sure they fit very snugly and line up evenly. Hot glue a 3"- to 4"-wide strip of foam board to cover the entire length of the seam.

Step 5: Add easel back if needed. Cut out a 90-degree triangle from foam core. On the side with the 90-degree corner, score 1" out from the edge to create a glue tab. Bend the scored edge, and hot glue it.



Large Orchid

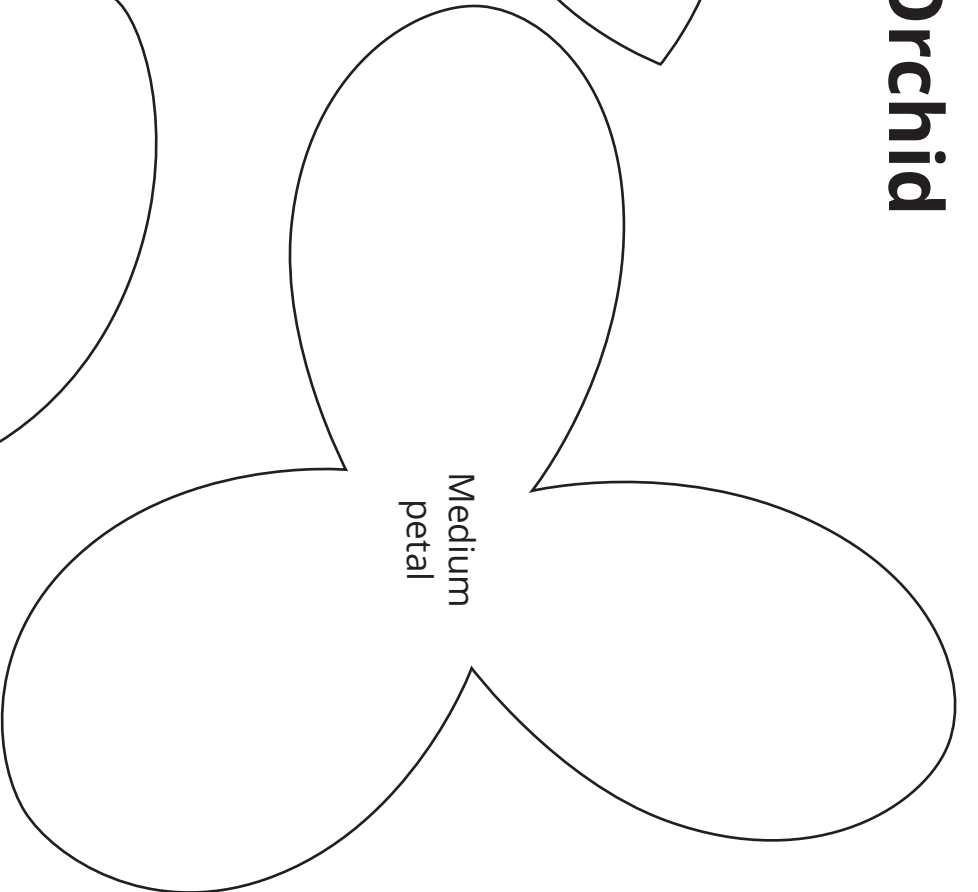
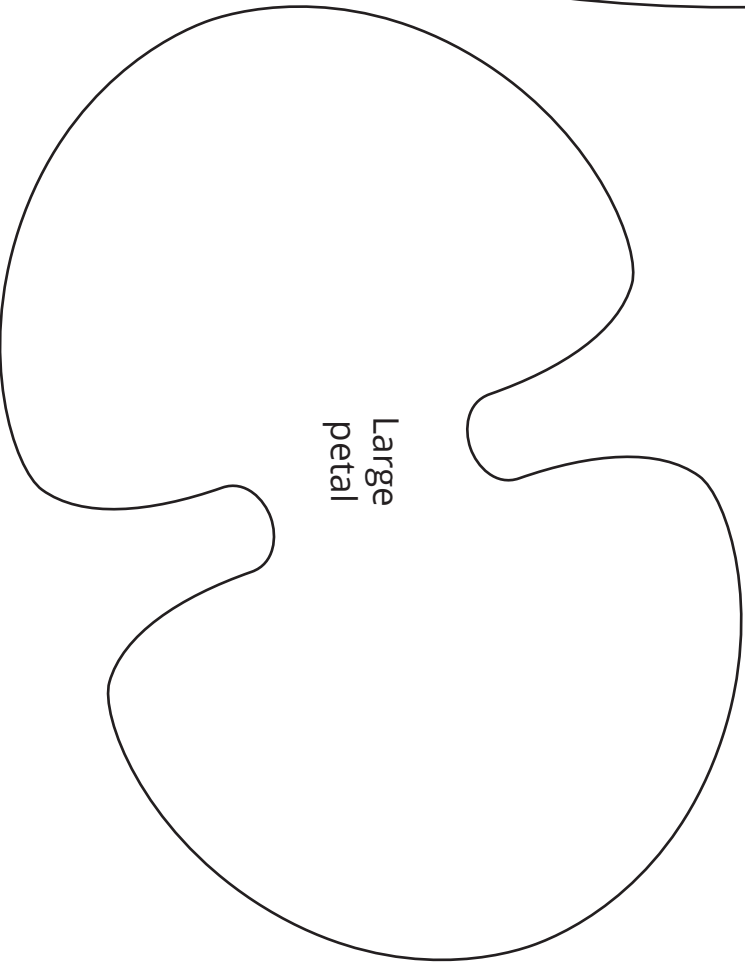
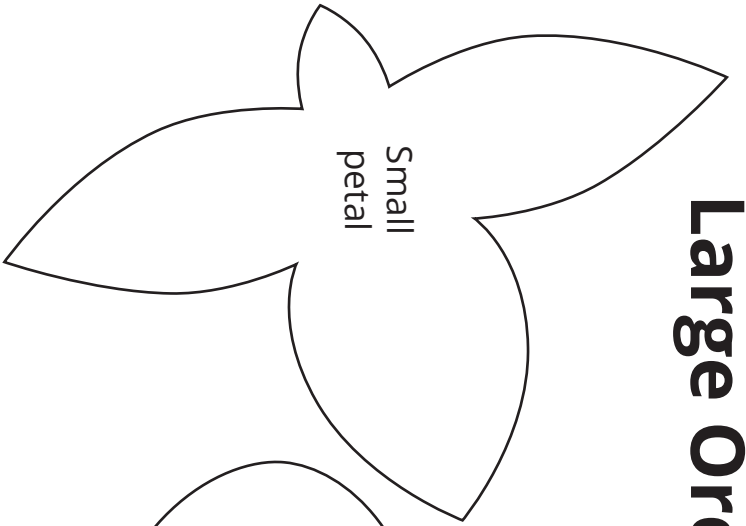
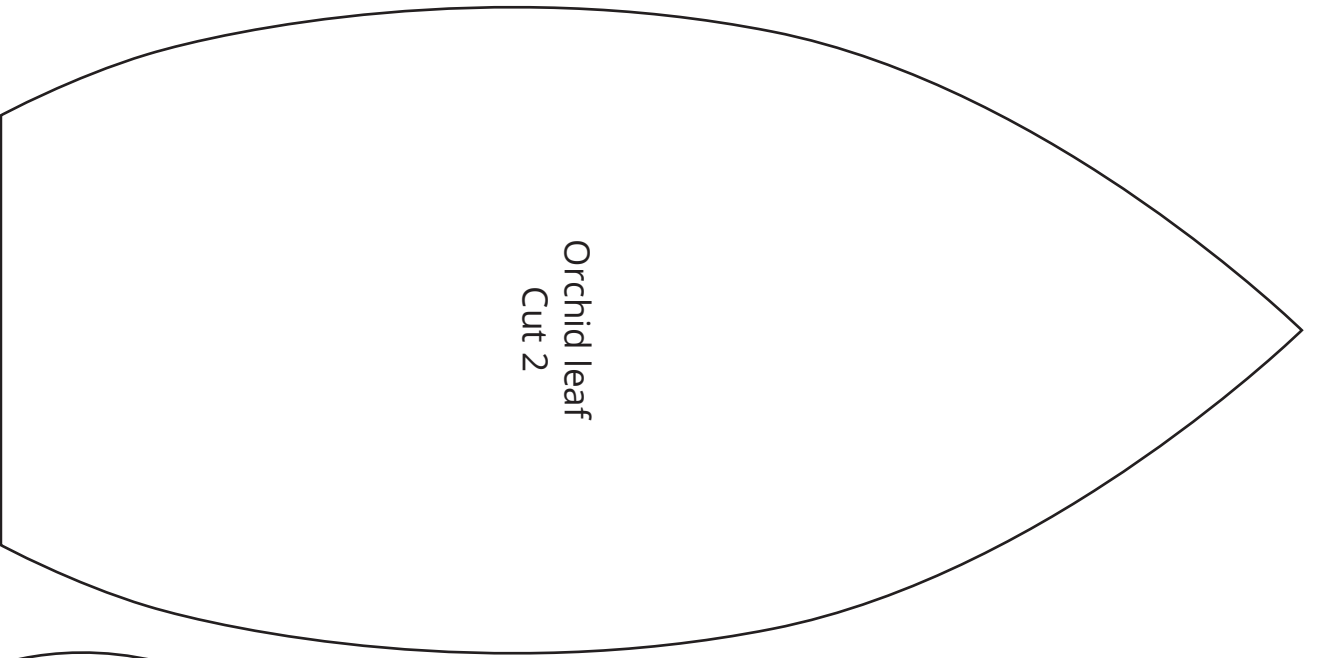

Center piece

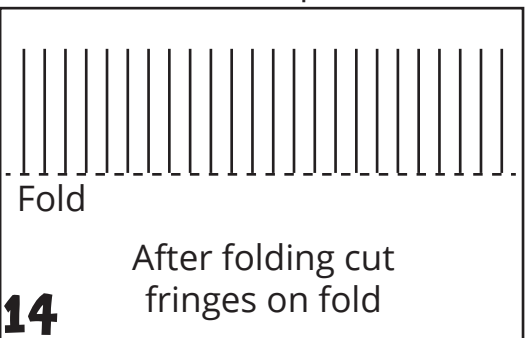

Small Orchid

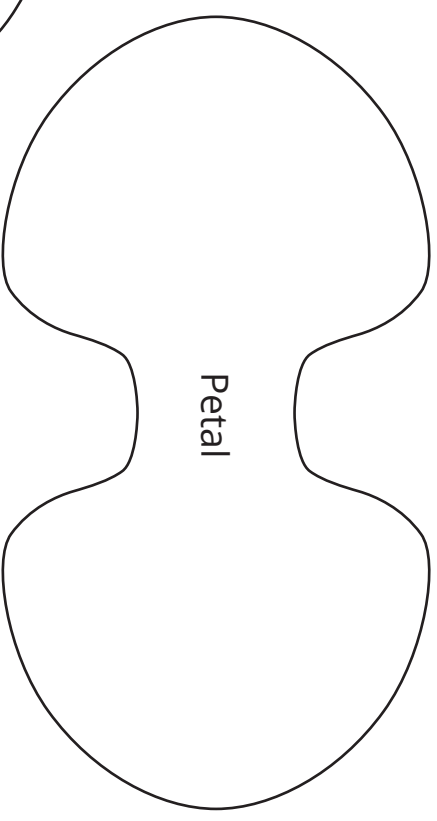
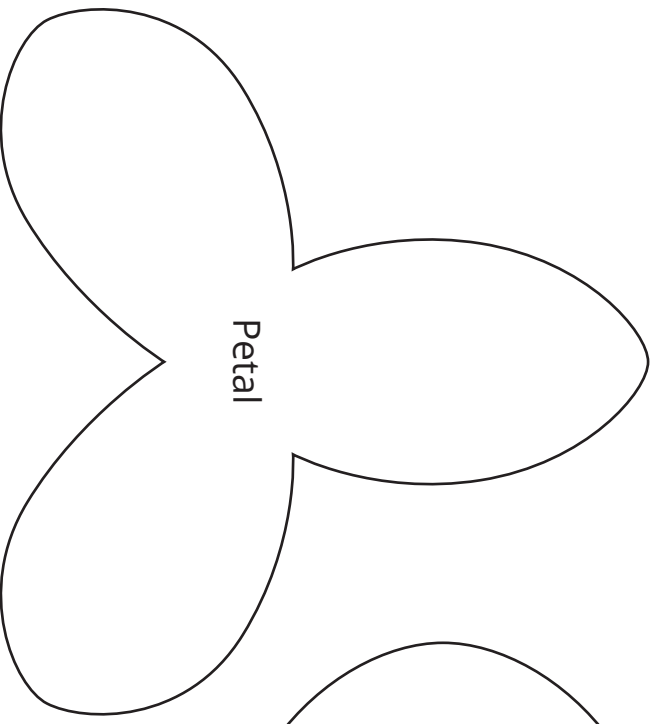
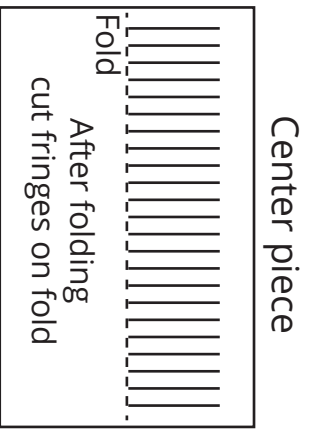
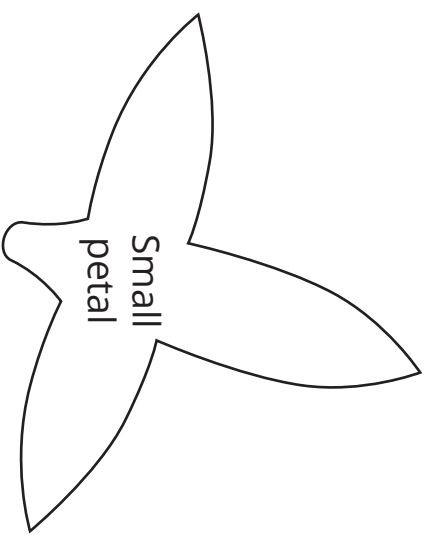
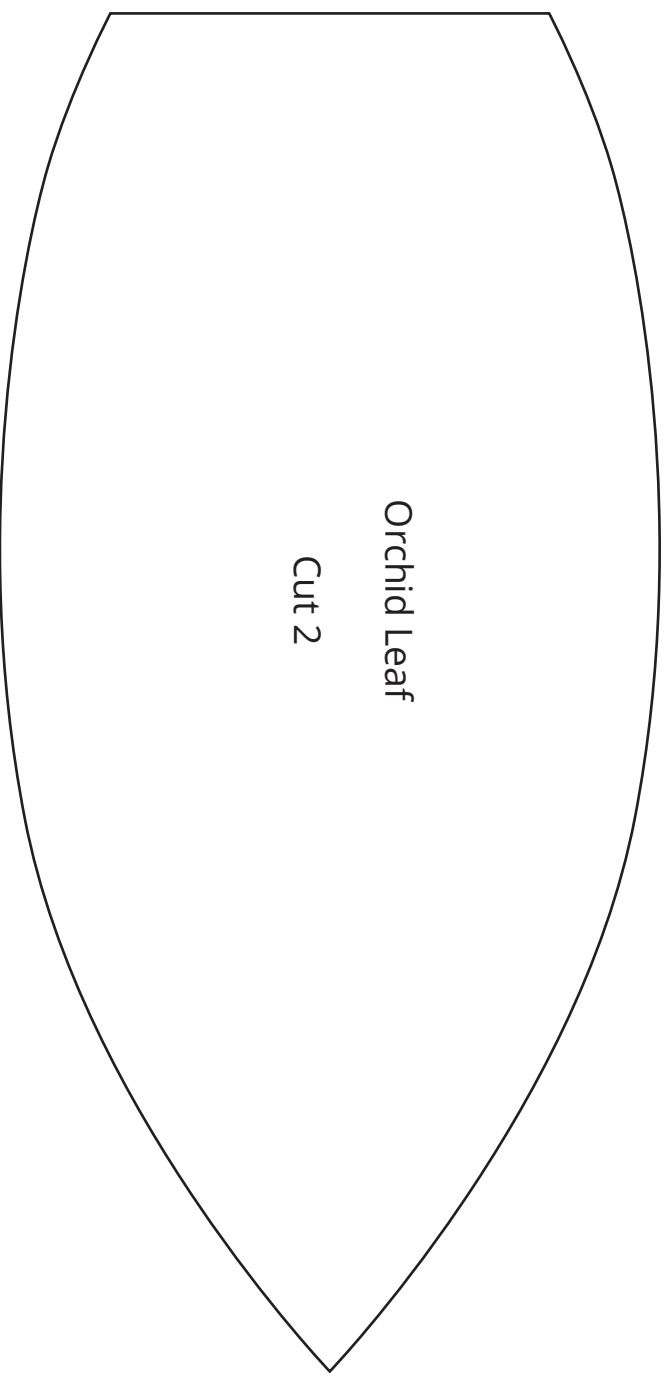

Bird of Paradise

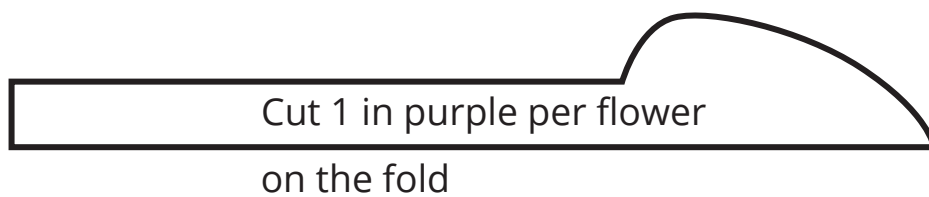
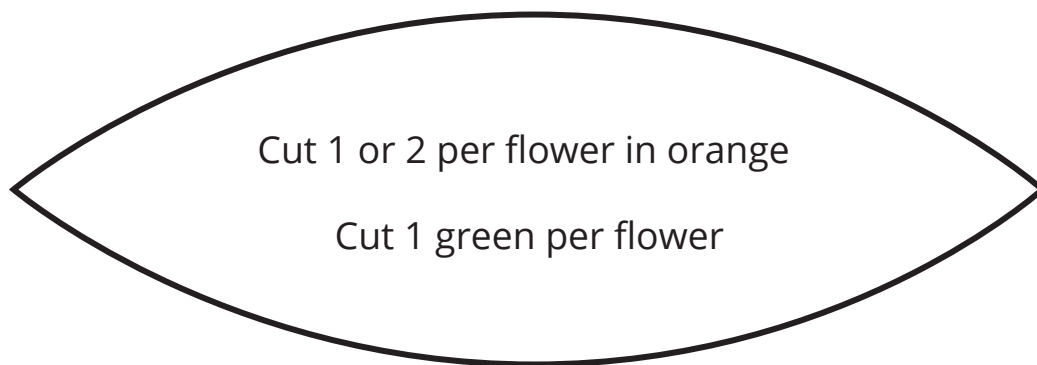
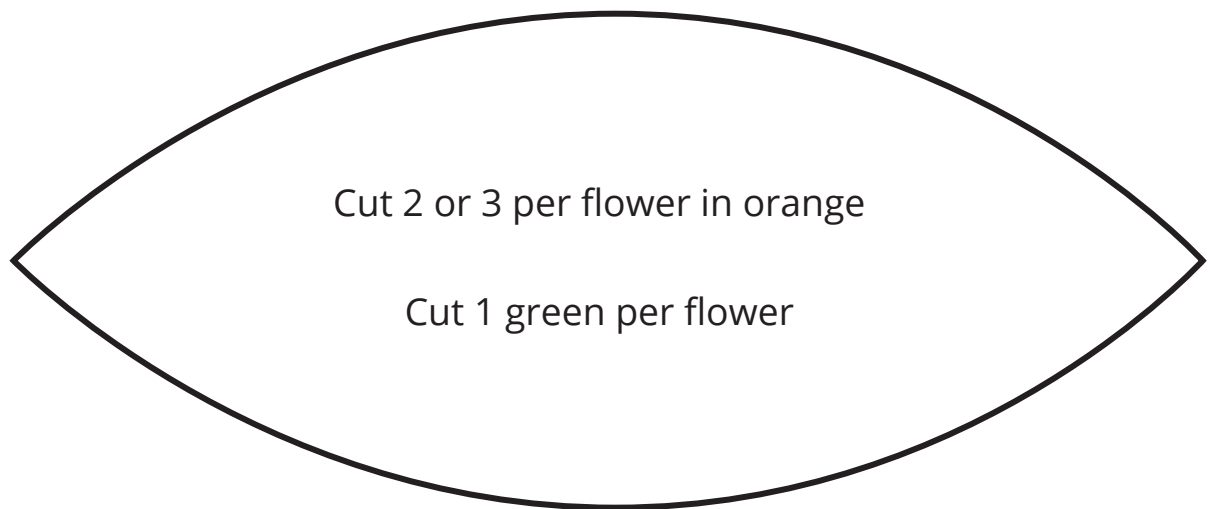

Anthuriums

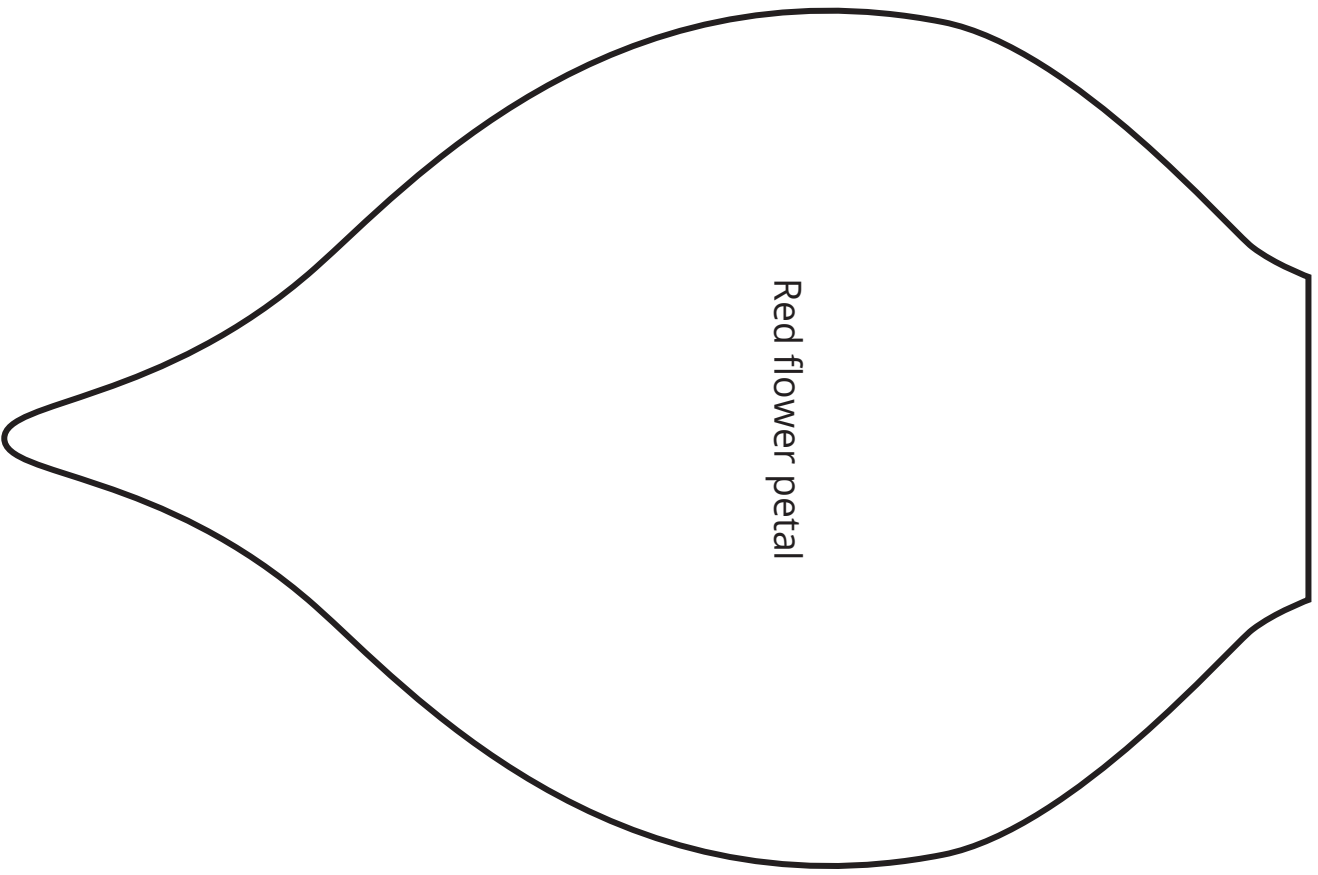

Red flower petal

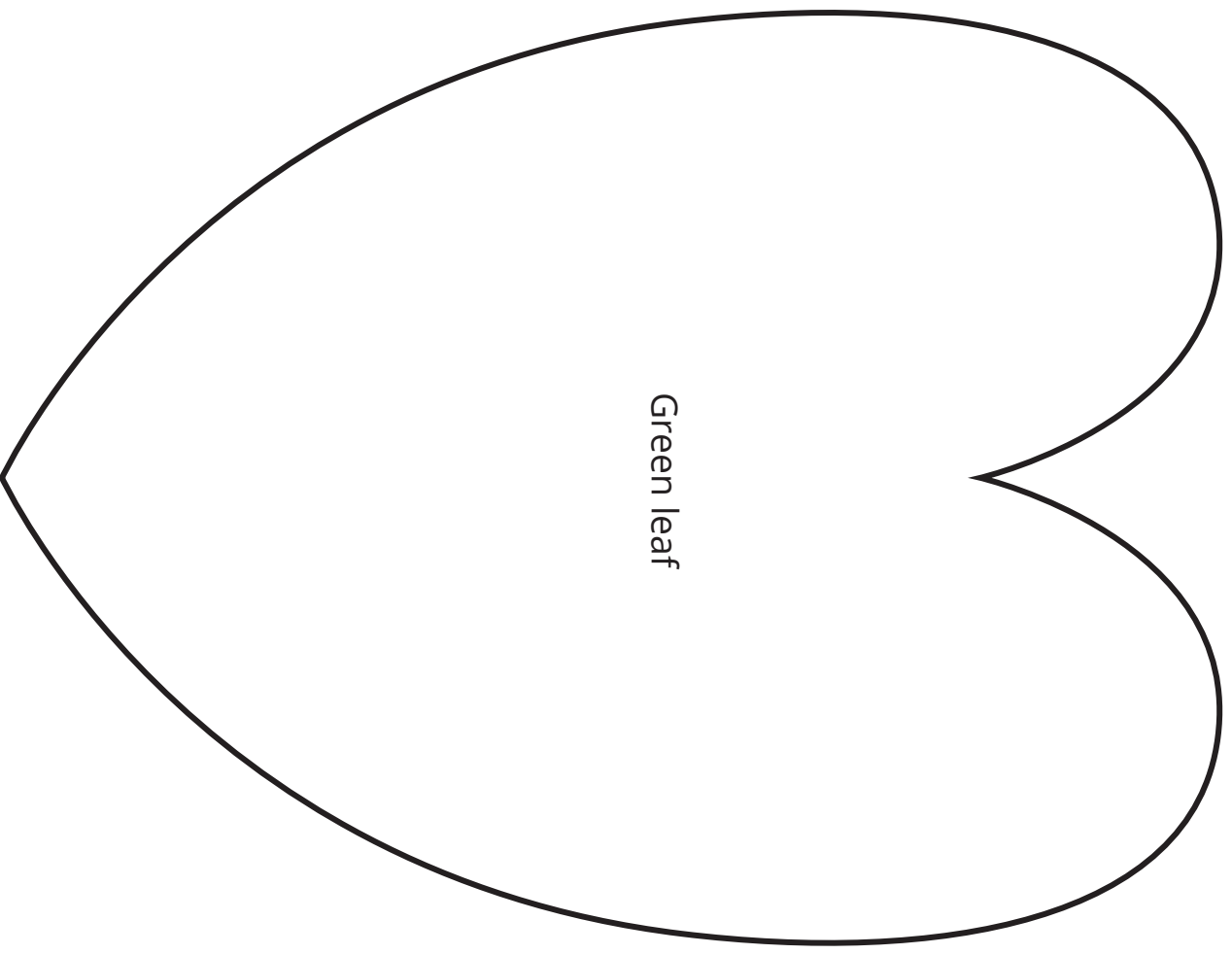

Green leaf

