



the **GOSPEL**
of **MARK**



The Trials

- The last chance to accept Messiah
 - Christ or Barabbas?
 - Pilate knew they were jealous (10) envy
 - “crucify Him” is the demand
 - “Why, what evil has He done?”
 - Pilate declared him innocent – again!
 - Gives in to the mob...

Between Heaven and Earth

- Jn 19:14 – 6th hr, Roman Time – 6am
- Mark was writing to people who saw crucifixions! Not much was needed
- Scourging was not a normal part of it
 - Separate punishment, usually death resulted
 - Roman Cohort (16) Fortress of Antonia

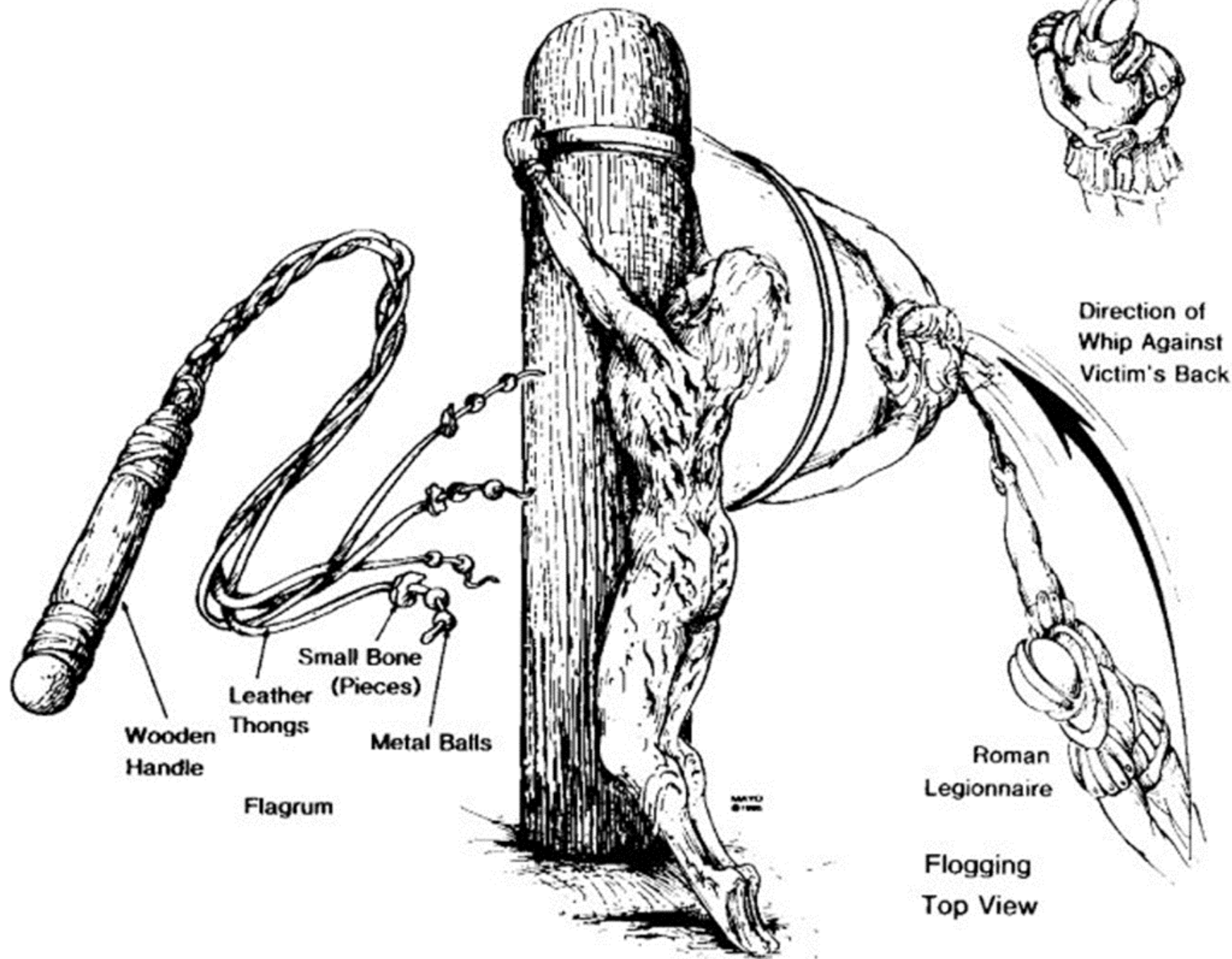

Direction of
Whip Against
Victim's Back

Wooden
Handle

Leather
Thongs

Small Bone
(Pieces)

Metal Balls

Flagrum

Roman
Legionnaire

Flogging
Top View

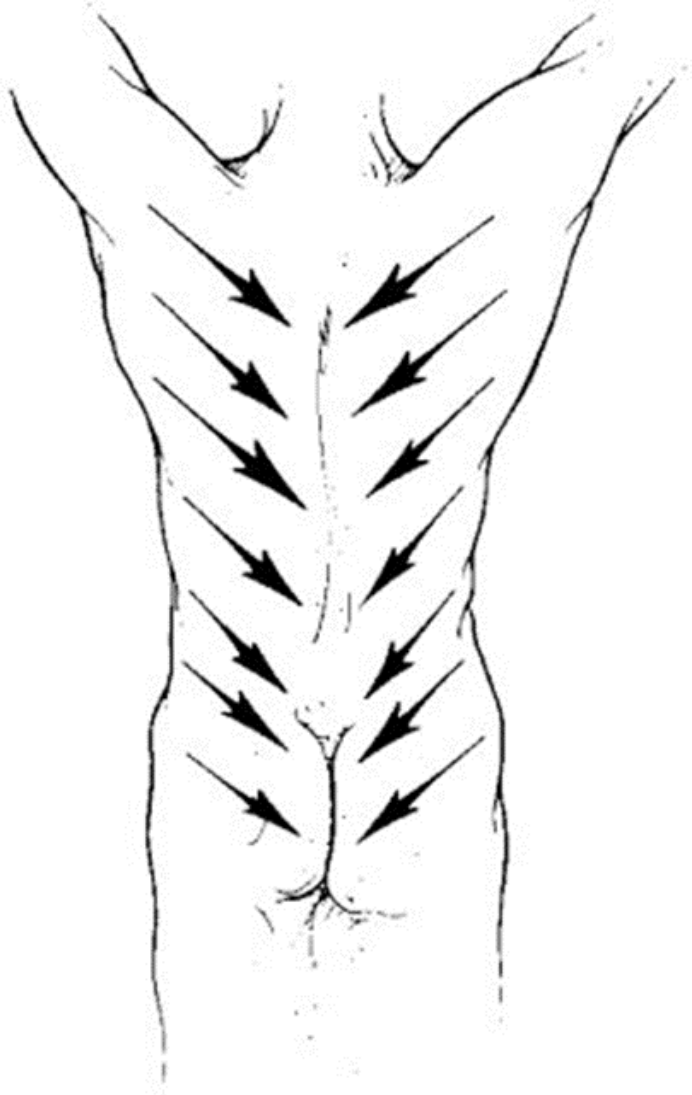

Direction of Whip Marks

Victim

The 'substitute'

- Mocked, beaten, thorns, purple robe
 - All for our sins...
 - For EVERY sin...
- Jesus had been up all night, beaten 2x, scourged, mocked and is sent to Calvary



Simon the Cyrene (21)

- The father of Alexander, Rufus Ro 16:13?
- Carries cross beam 75-125 lbs
 - Jesus was worn out from the scourging
 - All night beatings... Jews and Romans
 - Much loss of Blood

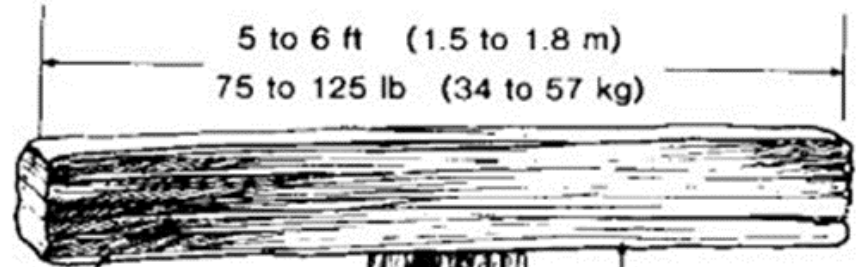

Patibulum

Titulus

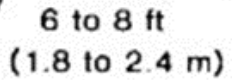
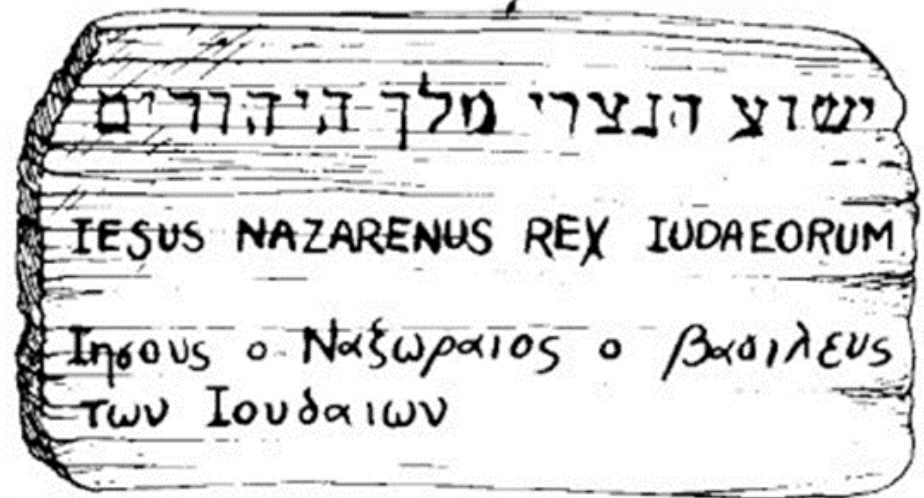

Sedile

Stipes

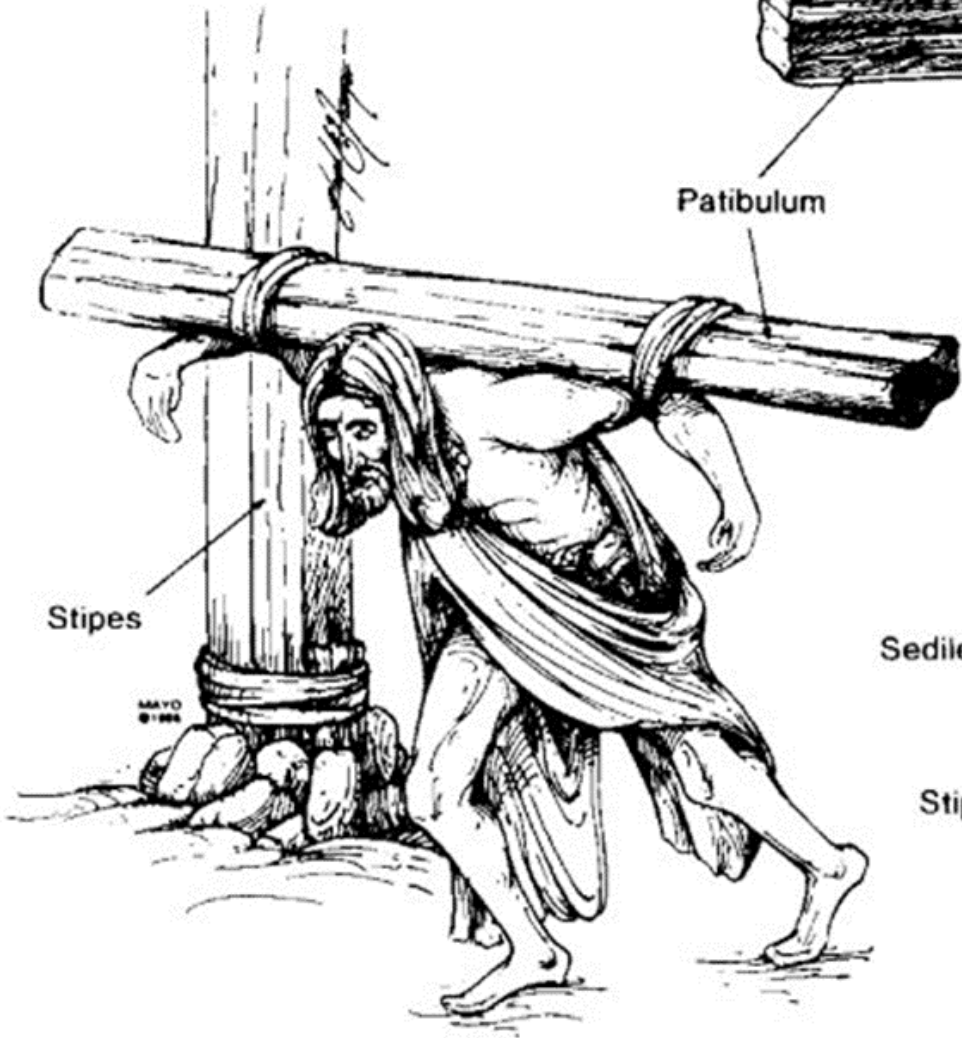
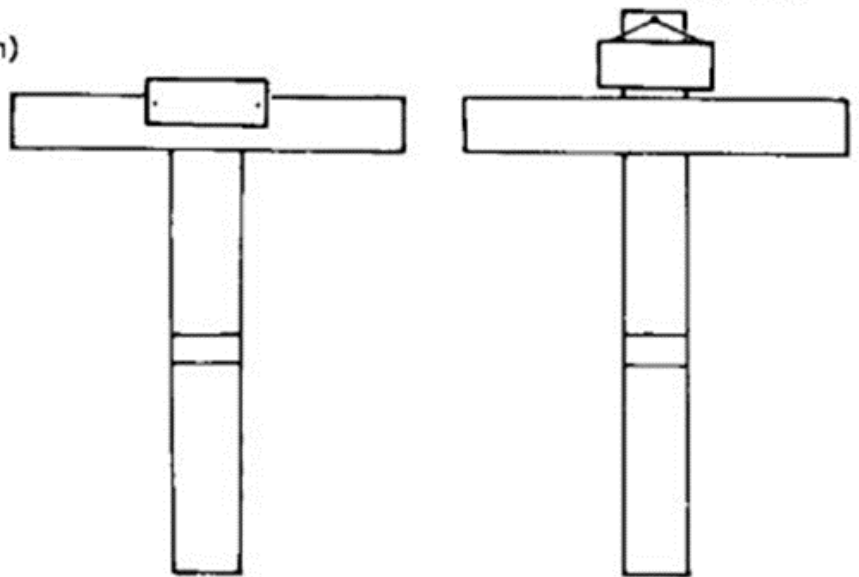

Stipes

MAYO © 1988







Son of Man

- Refuses the numbing 'wine' (23)
 - Jesus took the full fury of the cross
- Dividing up the garments
 - Fulfillment of scripture...Ps 22:18
 - This was a bonus for doing the crucifixion
- Crucified with 2 robbers –
 - From, to, and for sin...
 - 33 – Jewish time – noon till 3pm

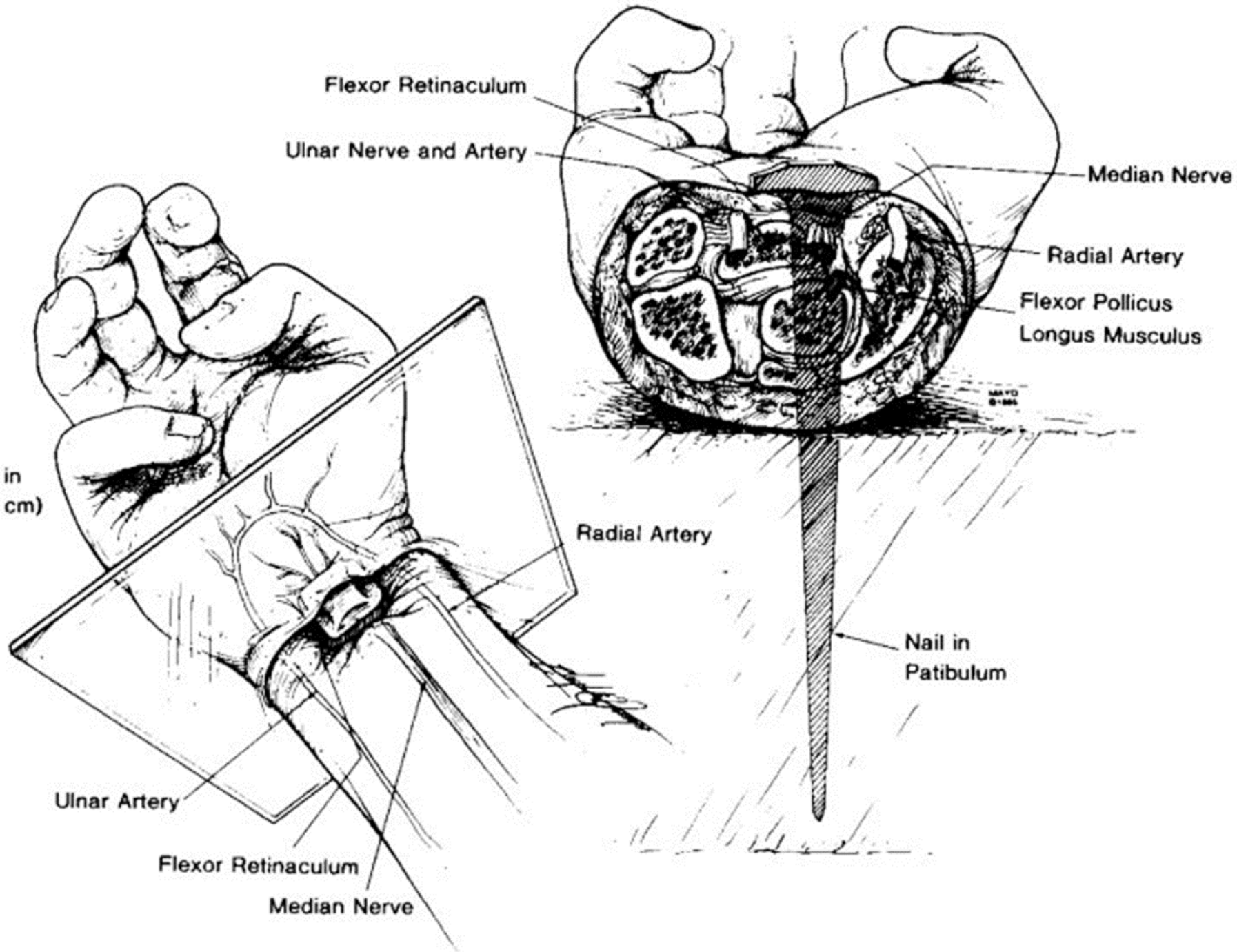
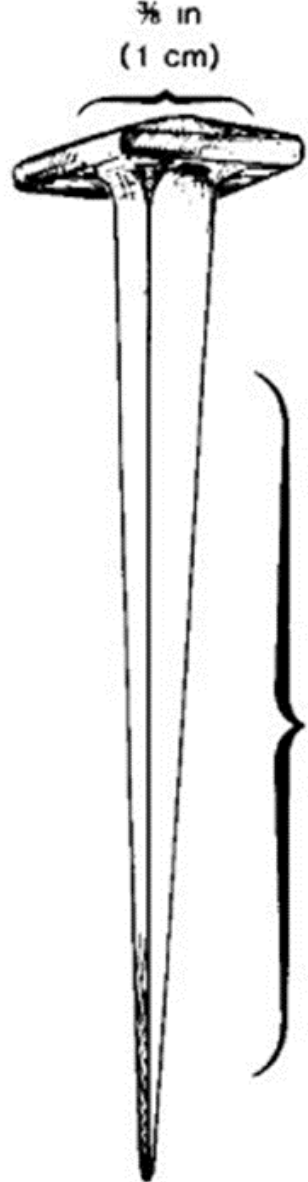

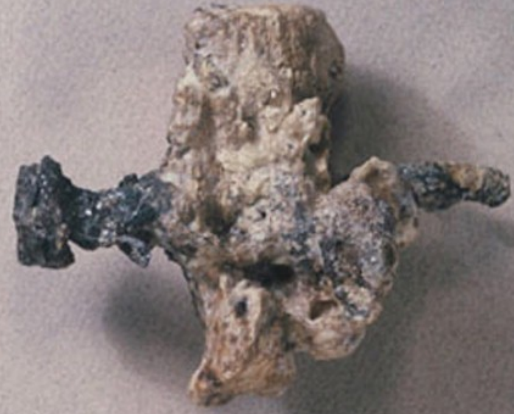

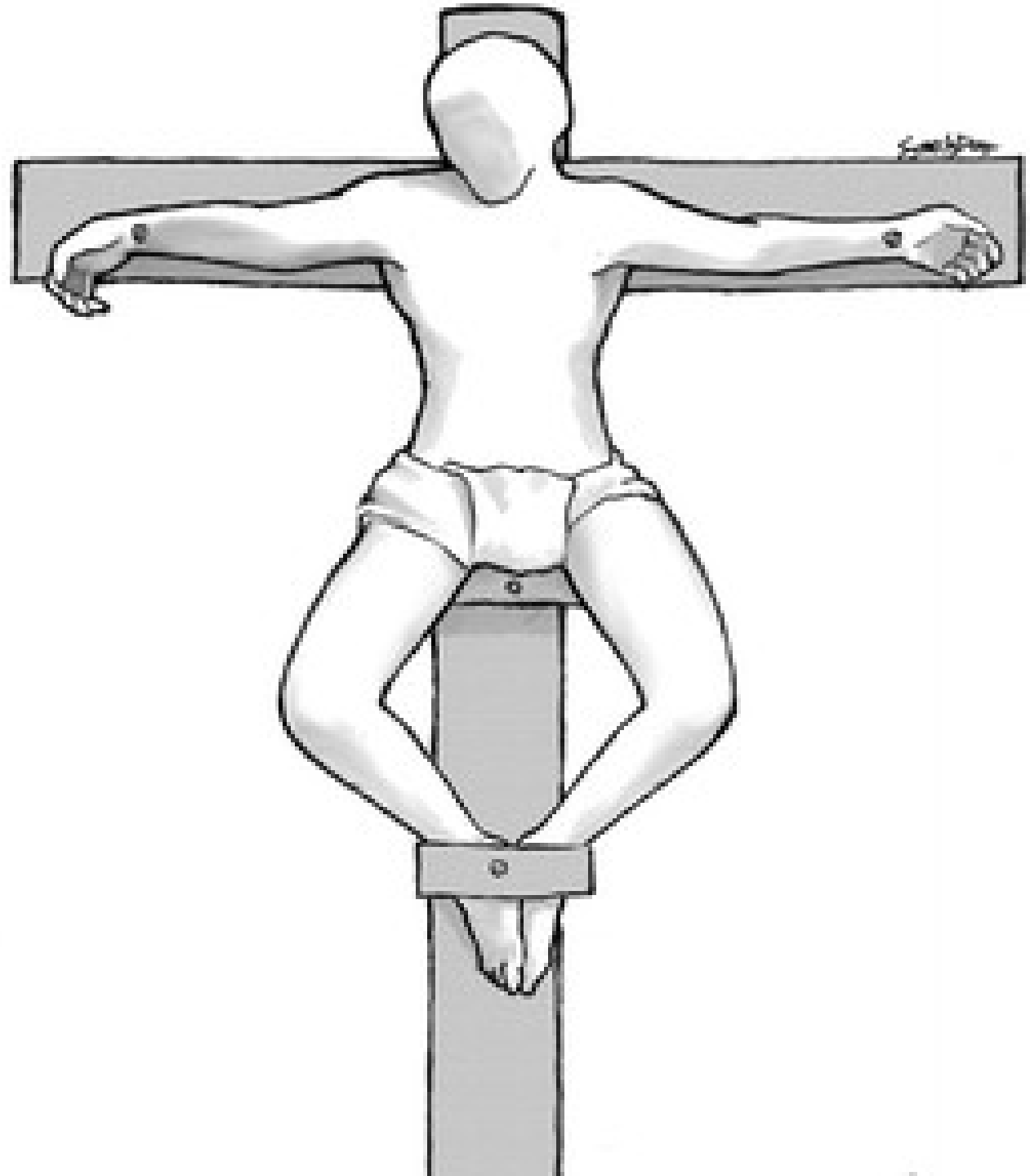
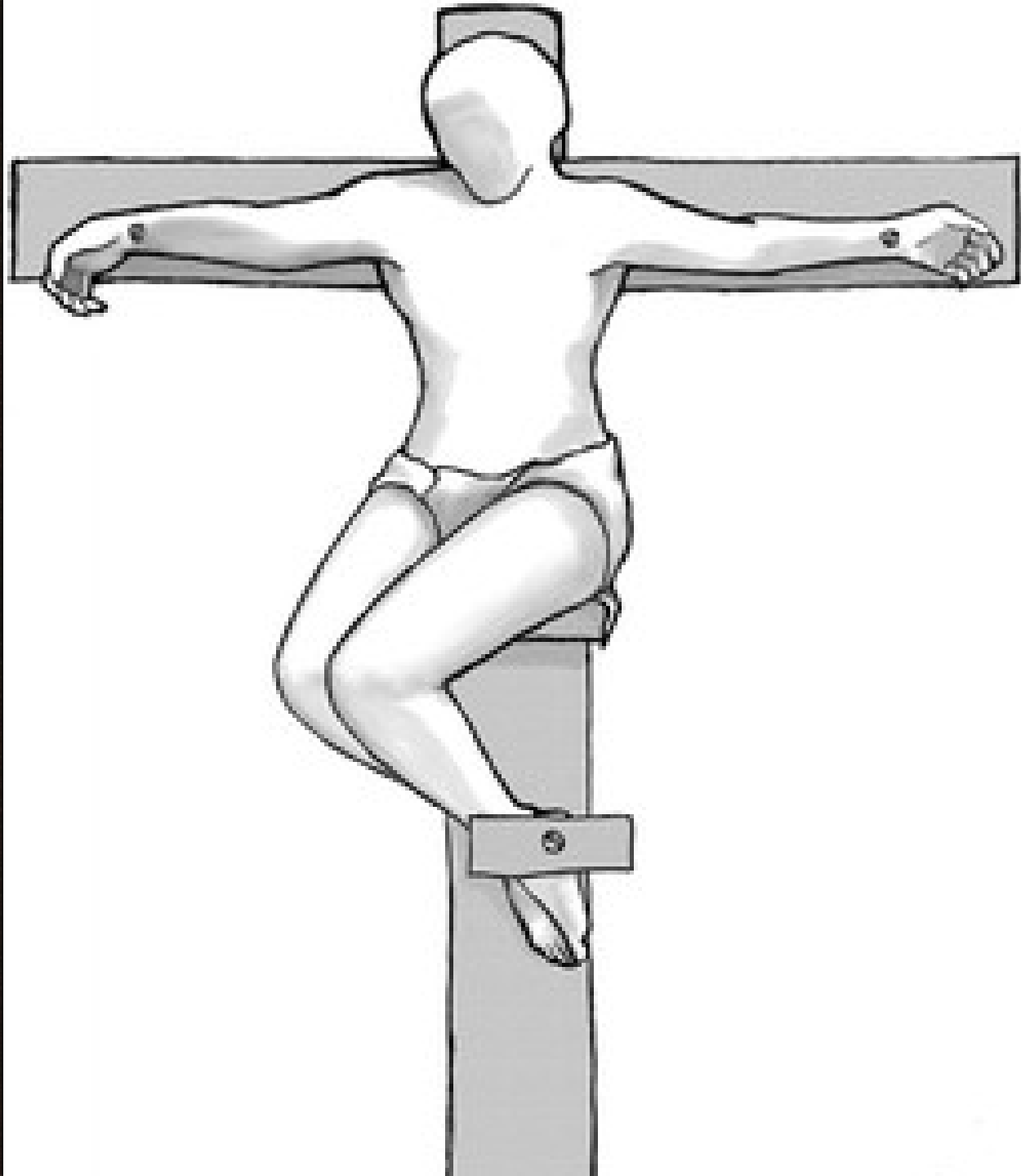

From the cross

- 2/7 mentioned by Mark
 - 34 – cry of judgment... separated Godhead
 - 37 – “loud cry” ?
- Results of the Death of Christ
 - Temple curtain torn – top to bottom... (38)
 - Access for all to God
 - Centurion’s response – Son of God!!! (39)

For further study - resources

- <http://www.frugalsites.net/jesus/welcome.html>
- <http://www.uncc.edu/jdtabor/galleryb.html>